



ESD5100 Series Speed Control Unit

1 INTRODUCTION

The ESD5100 Series speed control unit is an all electronic device designed to control engine speed with fast and precise response to transient load changes. This closed loop control, when connected to a proportional electric actuator and supplied with a magnetic speed sensor signal, will control a wide variety of engines in an isochronous or droop mode. It is designed for high reliability and is hard potted to withstand the engine environment.

NOTE The ESD5131 is a derivation of the standard GAC ESD5111 Speed Control Unit. All specifications, installation procedures, and adjustments, except those noted are identical. The ESD5131 comes with DIP switches which allow for the selection of the Lead Circuit and Soft Coupling features. The ESD5111 comes with the Lead circuit already enabled via a jumper across posts E7 and E6. See Section 8.

2 SPECIFICATIONS

PERFORMANCE	
Isochronous Operation	±0.25 % or better
Speed Range /Governor	1K - 7.5K Hz Continuous
Speed Drift with Temperature	±0.5% Typical
Idle Adjust CW	Min. 1200 Hz Below set speed
Idle Adjust CCW	Min. 4100 Hz Below set speed
Droop Range	1 - 5% Regulation*
Droop Adj. Max. (K-L Jumpered)	875 Hz., ±75 Hz per 1.0 A change
Droop Adj. Min. (K-L Jumpered)	15 Hz., ±6 Hz per 1.0 A change
Speed Trim Range	±200 Hz
Remote Variable Speed Range	500 - 3.7 kHz
Terminal Sensitivity	J 115 Hz., ±15 Hz/Volt @ 5 K Impedance L 735 Hz., ±60 Hz/Volt @ 65 K Impedance N 148 Hz., ±10 Hz/Volt @ 1 M Impedance P 10 VDC Supply @ 20 mA Max.
PHYSICAL	
Dimensions	See Outline Diagram 4
Weight	1.2 lb.(0.545 kg)
Mounting	Any Position, vertical preferred
RELIABILITY	
Vibration	1G, 20-100 Hz
Testing	100% Functionally Tested
ENVIRONMENTAL	
Ambient Temperature	-40° to +185°F (-40° to +85°C)
Relative Humidity	up to 95%
All Surface Finishes	Fungus proof and corrosion resistant
RoHS Regulation	Compliant
INPUT POWER	
DC Supply	12 or 24 VDC Battery Systems (Transient and Reverse Voltage Protected)
Polarity	Negative Ground (case isolated)
Power Consumption	100 mA (No actuator current)
Speed Signal Range	0.5 – 50 VAC
Actuator Current Range	10 Amps continuous @ 77°F (25°C)
Speed Signal Range	1.0 to 50.0 VAC
COMPLIANCE / STANDARDS	
Agency	CE Requirements

3 CONTROLLER MODELS

PART NUMBER	FEATURES
ESD5111	Multi VDC / Standard Unit
ESD5111T	Multi VDC / Temperature Compensated
ESD5119	Multi VDC / Cummins EFC Reverse Acting (Normally open)
ESD5120	Multi VDC / Light-Force (Low Current Optimized) Cummins EFC Forward Acting (Normally Closed)
ESD5131	Multi VDC / Switchable Soft Coupling and Lead Circuit
ESD5159	Multi VDC / Expanded Frequency Range to 14 kHz
ESD5160	Multi VDC / Cummins EFC Reverse Acting for Fire Pump Applications / Expanded Frequency Range to 10.5 kHz

4 OUTLINE DIAGRAM

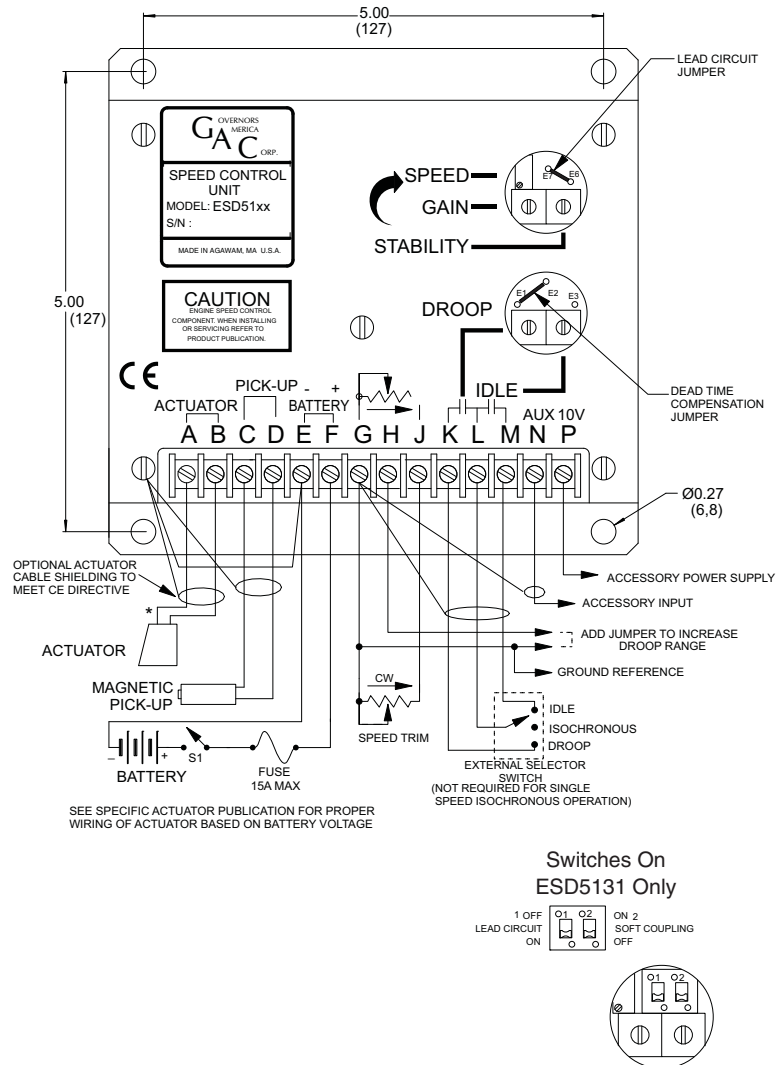

5 INSTALLATIONS

See Section 4 for more dimensions

Vertical orientation allows fluids to drain in moist environments.



Mount in a cabinet, engine enclosure, or sealed metal box.



Avoid Extreme Heat

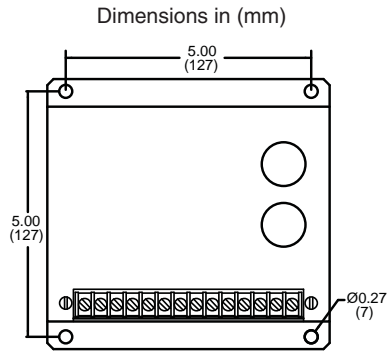

WARNING

An overspeed shutdown device, independent of the governor system, should be provided to prevent loss of engine control which may cause personal injury or equipment damage. Do not rely exclusively on the governor system electric actuator to prevent overspeed. A secondary shutoff device, such as a fuel solenoid must be used.

6 WIRING

See Section 3 for the Wiring Diagram

TERMINAL	DEFINITION	NOTES
A & B	Actuator (+/-)	#16 AWG (1.3 mm sq) or larger wire
C & D	Magnetic Speed Pickup (D is ground)	Wires must be twisted and/or shielded for their entire length Gap between speed sensor and gear teeth should not be smaller than 0.025 in. (.64mm) and no larger than 0.035 in. (.89 mm) Speed sensor voltage should be at least 1VAC RMS during crank
E & F	Battery Power (-/+)	#16 AWG (1.3mm sq) or larger wire A 15 amp fuse must be installed in the positive battery lead to protect against reverse voltage Battery positive (+) input is Terminal F
G	Ground Signal	
H		Add jumper to increase droop range
J	Variable Speed Input	5K Resistive Nominal
K & L	Droop Select	Active when closed
M & L	Idle Select	Active when closed
N	Accessory Input	Sensitivity: 148 Hz \pm 10 Hz/V @1M Impedance Input is centered at 5.0V \pm 0.1V Load Sharing / Synchronizing, 0-10V Input Accessory connections must be shielded.
P	Accessory Power Supply	+10 Volt Output

RECOMMENDATIONS

- Shielded cable should be used for all external connections to the ESD control.
- One end of each shield, including the speed sensor shield, should be grounded to a single point on the ESD case.

7 ADJUSTMENTS

BEFORE STARTING THE ENGINE

Make sure the following adjustments are set before starting the engine.

GAIN	Middle Position
STABILITY	Middle Position
SPEED TRIM CONTROL	Middle Position

START ENGINE

The speed control unit governed speed setting is factory set at approximately engine idle speed. (1000 Hz., Speed sensor signal or 600 RPM)

Crank the engine with DC power applied to the governor system. The actuator will energize to the maximum fuel position until the engine starts. The governor system should control the engine at a low idle speed. If the engine is unstable after starting, refer to Section ADJUSTING FOR STABILITY.

GOVERNOR SPEED SETTING

The governed speed set point is increased by clockwise rotation of the SPEED adjustment control. SPEED adjustment is a 25 turn potentiometer.

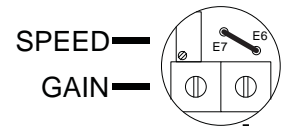

STABILITY

ADJUSTING FOR STABILITY

Once the engine is running at operating speed and at no load, the following governor performance adjustments can be made to increase engine stability.

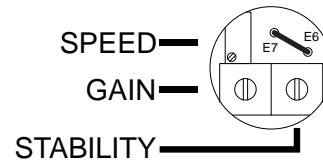

STABILITY ADJUSTMENT

PARAMETER	PROCEDURE
A. GAIN	<ol style="list-style-type: none"> Rotate the GAIN adjustment clockwise until instability develops. Then, gradually move the adjustment counterclockwise until stability returns. Finally, move the adjustment one division further counterclockwise to insure stable performance (270° potentiometer). If instability persists, adjust the next parameter.
B. STABILITY	<ol style="list-style-type: none"> Follow the same adjustment procedure, steps 1 - 3, as the GAIN parameter.

NOTE

Normally, adjustments made at no load achieve satisfactory performance. If further performance improvements are required, refer to Section 9 SYSTEM TROUBLESHOOTING. Information can be found regarding the adjustment of the DIP switch positions on the ESD.

8 ADDITIONAL FEATURES & OPTONAL WIRING

IDLE SPEED SETTING

After the governor speed setting had been adjusted, place the optional external selector switch in the IDLE position. The idle speed set point is increased by the clockwise rotation of the IDLE adjustment control. When the engine is at idle speed, the speed control unit applies droop to the governor system to insure stable operation.

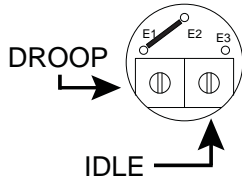

SELECTABLE LEAD CIRCUIT & SOFT COUPLING ESD5131 ONLY

Switch 1(C1) controls the "Lead Circuit" found in the ESD5131. The normal position is "ON." Move the switch to the "OFF" position if there is fast instability in the system.

Switch 2(C2) controls an additional circuit added in the ESD5131 that is designed to eliminate fast erratic governor behavior, caused by very soft or worn couplings in the drive train between the engine and generator. The normal position is "OFF." Move to the "ON" position if fast erratic engine behavior due to a soft coupling is experienced.

IMPORTANT:

Speed Adjustment Is a 25 Turn Potentiometer

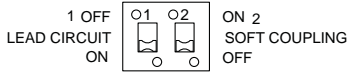
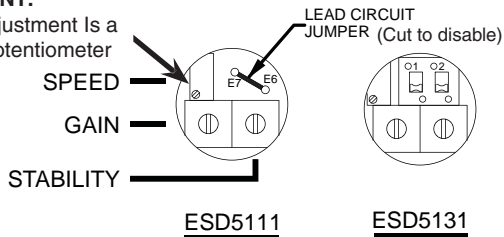

NOTE All ESD5100 Series speed controllers come with the Lead Circuit enabled. Cut the jumper between posts E6 and E7 to disable. ESD5131 has a switch to disable the Lead Circuit.

SPEED DROOP OPERATION

Droop is typically used for the paralleling of engine driven generators. When in droop operation, the engine speed will decrease as engine load increases. The percentage of droop is based on the actuator current change from no engine load to full load.

1. Place the optional external selector switch in the DROOP position. DROOP is increased by clockwise rotation of the DROOP adjustment control.
2. After the droop level has been adjusted, the rated engine speed setting may need to be reset. Check the engines speed and adjust that speed setting accordingly.

NOTE Though a wide range of droop is available with the internal control, droop level requirements of 10% are unusual. If droop levels experienced are higher or lower than those required, contact GAC for assistance.

ACCESSORY INPUT

The Auxilliary Terminal N accepts signals from load sharing units, auto synchronizers and other governor system accessories, GAC accessories are directly connected to this terminal.

NOTE When an accessory is connected to Terminal N, the speed will decrease and the speed adjustment must be reset.

When operating in the upper end of the control unit frequency range, a jumper wire or frequency trim control may be required between Terminals G and J. This increases the frequency range of the speed control to over 7000 Hz.

If the auto synchronizer is used alone, not in conjunction with a load sharing module, a 3m ohm resistor should be connected between Terminals N and P. This is required to match the voltage levels between the speed control unit and the synchronizer.

ACCESSORY SUPPLY

The +10 volt regulated supply, Terminal P, can be utilized to provide power to GAC governor system accessories. Up to 20 mA of current can be drawn from this supply. Ground reference is Terminal G.

CAUTION A short circuit on this terminal will damage the speed control unit.

WIDE RANGE REMOTE SPEED OPERATION

A single remote speed adjustment potentiometer can be used to adjust the engine speed continuously over a specific speed range.

Select the desired speed range and corresponding potentiometer value. (Refer to TABLE 1) If the exact range cannot be found, select the next higher range potentiometer.

To maintain engine stability at the minimum speed setting, a small amount of droop can be added using the DROOP adjustment. At the maximum speed setting the governor performance will be near isochronous, regardless of the droop adjustment setting.

NOTE An additional fixed resistor may be placed across the potentiometer to obtain the exact desired range. Connect the speed range potentiometer as shown below. Contact GAC for assistance if difficulty is experienced in obtaining the desired variable speed governing performance.

TABLE 1

SPEED FREQUENCY RANGE	POTENTIOMETER VALUE
900 Hz	1 K
2400 Hz	5 K
3000 Hz	10 K
3500 Hz	25 K
3700 Hz	50 K

Conversion Formulas

$$\text{Hertz}_{\text{MAG PICKUP}} = \frac{(\text{RPM} \times \# \text{Teeth})}{60\text{sec}}$$

$$\text{RPM} = \frac{(\text{Hertz}_{\text{MAG PICKUP}} \times 60\text{sec})}{\# \text{Teeth}}$$

Trim Pot. Wiring

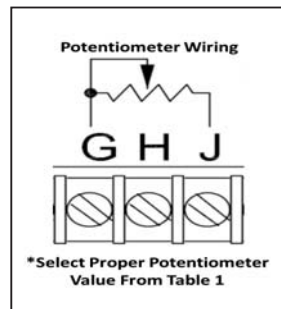

Wide Range Remote Variable Speed Pot. Wiring

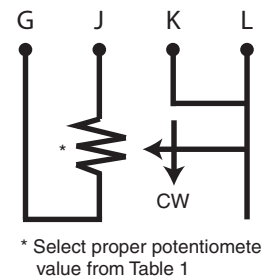

9 SYSTEM TROUBLESHOOTING

INSUFFICIENT MAGNETIC SPEED SIGNAL

A strong magnetic speed sensor signal will eliminate the possibility of missed or extra pulses. The speed control unit will govern well with 1.0 VAC speed sensor signal. A speed sensor signal of 3 volts VAC or greater at governed speed is recommended. Measurement of the signal is made at Terminals C and D.

The amplitude of the speed sensor signal can be raised by reducing the gap between the speed sensor tip and the engine ring gear. The gap should not be any smaller than 0.025 in (0.64 mm). When the engine is stopped, back the speed sensor out by 3/4 turn after touching the ring gear tooth to achieve a satisfactory air gap.

SYSTEM INOPERATIVE

If the engine governing system does not function, the fault may be determined by performing the voltage tests described in Steps 1 through 4. Positive (+) and negative (-) refer to meter polarity. Should normal values be indicated during troubleshooting steps, and then the fault may be with the actuator or the wiring to the actuator. Tests are performed with battery power on and the engine off, except where noted. See actuator publication for testing procedure on the actuator.

STEP	WIRES	NORMAL READING	PROBABLE CAUSE OF ABNORMAL READING
1	F(+) & E(-)	Battery Supply Voltage (12 or 24 VDC)	<ol style="list-style-type: none"> DC battery power not connected. Check for blown fuse. Low battery voltage. Wiring error.
2	C(+) & D(-)	1.0 VAC minimum while cranking	<ol style="list-style-type: none"> Gap between speed sensor and gear teeth too great. Check Gap. Improper or defective wiring to the speed sensor. Resistance between D and C should be 160 to 1200 ohms. See specific mag pickup data for resistance. Defective speed sensor.
3	P(+) & G(-)	10 VDC, Internal Supply	<ol style="list-style-type: none"> Short on Terminal P. Defective speed control unit.
4	F(+) & A(-)	1.0 - 2.0 VDC while cranking	<ol style="list-style-type: none"> SPEED parameter set too low. Short/open in actuator wiring. Defective speed control. <p>Defective actuator, see Actuator Troubleshooting.</p>

INSTABILITY

Instability in a closed loop speed control system can be categorized into two general types. PERIODIC appears to be sinusoidal and at a regular rate. NON-PERIODIC is a random wandering or an occasional deviation from a steady state band for no apparent reason.

INSTABILITY	SYMPTOM	PROBABLE CAUSE OF ABNORMAL READING
Fast Periodic	The engine seems to jitter with a 3Hz or faster irregularity of speed.	<ol style="list-style-type: none"> Turn off other electrical equipment that may be causing interference. Readjust the GAIN and STABILITY for optimum control. Remove the E6 to E7 jumper (This reduces sensitivity to high frequencies). If system is still unstable, remove the E1 to E2 jumper and readjust GAIN and STABILITY.

Slow Periodic	An irregularity of speed below 3Hz.	<ol style="list-style-type: none"> Readjust the GAIN and STABILITY Set DIP switches 1 and 2 to "ON" in the following order: First SW1, Second SW2 Check fuel system linkage during engine operation for: <ol style="list-style-type: none"> binding high friction poor linkage Adjust the DEAD TIME COMPENSATION by adding a capacitor from post E2 to E3 (negative on E2) Start with 10 mfd and increase until instability is eliminated.
Non-Periodic	Erratic Engine Behavior	<ol style="list-style-type: none"> Increasing the GAIN should reduce the instability but not totally correct it. If this is the case, there is most likely a problem with the engine itself. Check for: <ol style="list-style-type: none"> engine mis-firings an erratic fuel system load changes on the generator set voltage regulator. If throttle is slightly erratic, but performance is fast, then remove the jumper from E6 to E7.

UNSATISFACTORY PERFORMANCE

SYMPTOM	NORMAL READING	PROBABLE CAUSE OF ABNORMAL READING
Engine Over-speeds	1. Do Not Crank. Apply DC power to the governor system.	1. After the actuator goes to full fuel, disconnect the speed sensor at Terminal C & D. If the actuator is still at full fuel-speed then the speed control unit is defective.
	2. Manually hold the engine at the desired running speed. Measure the DC voltage between Terminals A(-) & F(+) on the speed control unit.	<ol style="list-style-type: none"> If the voltage reading is 1.0 to 2.0 VDC: <ol style="list-style-type: none"> SPEED adjustment is set above desired speed Defective speed control unit If voltage reading is above 2.0 VDC then check for: <ol style="list-style-type: none"> actuator binding linkage binding Set point of overspeed shut-down device set too low. If the voltage reading is below 1.0 VDC: <ol style="list-style-type: none"> Defective speed control unit
Overspeed Shuts Down Engine After Running Speed is Reached		<ol style="list-style-type: none"> Speed adjustment set too high. OVERSPEED set to close to running speed. Actuator or linkage binding. Speed control unit defective.

SYMPTOM	NORMAL READING	PROBABLE CAUSE OF ABNORMAL READING
Overspeed Shuts Down Engine Before Running Speed is Reached	1. Check impedance between Terminals C & D. Should be 160 to 1200 Ohms	1. OVERSPEED set too low. Adjust 5-6 turns CW. 2. Erroneous speed sensor signal. Check wiring.
Actuator does not energize fully	1. Measure the voltage at the battery while cranking.	1. If voltage is less than 7V for a 12V system, or 14V for a 24V system, check or replace the battery.
	2. Momentarily connect Terminals A and F. The actuator should move to the full fuel position.	1. Actuator or battery wiring in error 2. Actuator or linkage binding 3. Defective actuator 4. Fuse opens. Check for short in actuator or harness.
Engine remains below desired governed speed	1. Measure the actuator output, Terminals A & B, while running under governor control.	1. If voltage measurement is within 2 VDC of the battery supply voltage level, then fuel control is restricted from reaching full fuel position, possibly due to mechanical governor, carburetor spring, or linkage interference. 2. SPEED parameter set too low.